

Article number: 0106035

Description: Retaining ring JV 19

Measures

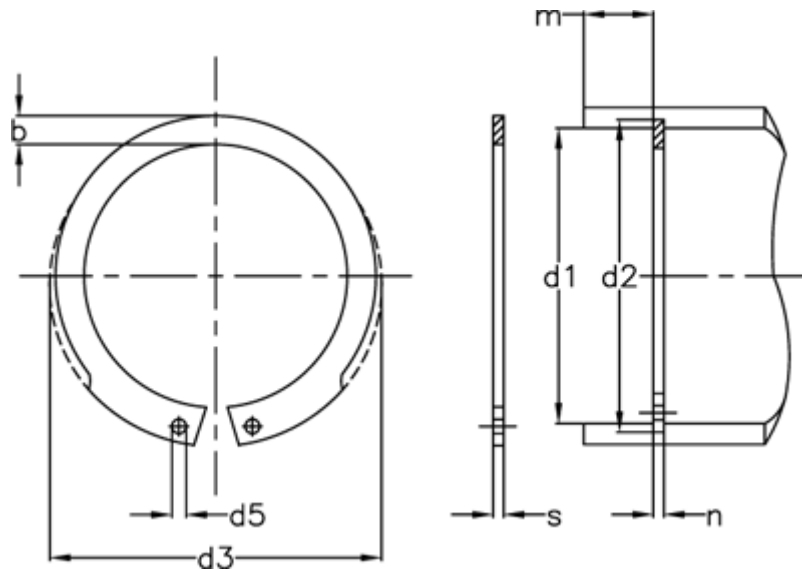

AN mm ²	= 15	FRg kN	= 2.8	tol	= 0.1
b	= 2.2	FR kN	= 6.6	tol	= -0.06
d1	= 19	g	= 1.0	tol	= +0,42-0,13
d2	= 20.0	K kN-mm	= 19.2	tol	= +0,15
d3	= 20.5	m min	= 1.10	Tong	= ZGJ-1
d5 min	= 1.3	Nominal drive	= 1.5	Weight kg/1000	= 0.66
Description	= JV 19	s	= 1.00		
FN kN	= 2.50	t	= 0.50		